

INFRARED LIGHT EMITTING DIODE

1.GENERAL DESCRIPTIONS

AT203-S-Y is high output power AlGaAs/Si infrared light emitting diode, mounted in clear epoxy package.

It emits spectrally narrow band of radiation peaking at 940nm. And the device is matched with phototransistor, photodiode and infrared receiver module.

2.FEATURES

- 1) Wide beam angle.
- 2) Good linearity, high response speed.
- 3) High output power.
- 4) Low cost.
- 5) ESD:5000V (HBM) , 500V (MM) .
- 6) MSL 2, acc. J-STD-020.

3.APPLICATIONS

- 1) Free air transmission system.
- 2) Infrared remote control units with high power requirement.
- 3) Smoke detector.
- 4) Infrared applied system.

4.ABSOLUTE MAXIMUM RATINGS AT Ta=25°C

PARAMETER	MAXIMUM RATING	UNIT
Power Dissipation	150	mW
Peak Forward Current *1	1.0	A
Continuous Forward Current	100	mA
Reverse Voltage	5	V
Operating Temperature Range	-25 to 85 °C	°C
Storage Temperature Range	-40 to +85°C	°C
Lead Soldering Temperature	260°C for 5 seconds max. (1.6 mm from Body)	°C

Notes: *1: I_{FP} Conditions--Pulse Width ≦ 100 μs and Duty ≦ 1%.

5.ELECTRICAL OPTICAL CHARACTERISTICS AT Ta=25°C

PARAMETER	SYMBOL	MIN.	TYP.	MAX.	UNIT	TEST CONDITION
Radiant Intensity	E _e	8	-	16	mW/sr	I _F =20mA
		-	70	-		I _F =100mA Pulse Width ≦ 100μs ,Duty ≦ 1%
		-	700	-		I _F =1A Pulse Width ≦ 100μs ,Duty ≦ 1%
Peak Emission Wavelength	λ _{peak}	-	940	-	nm	I _F =20mA
Spectral Line Half-Width	Δλ	-	45	-	nm	I _F =20mA
Forward Voltage	V _F	-	1.25	1.5	V	I _F =20mA
		-	1.45	1.7		I _F =100mA Pulse Width ≦ 100μs ,Duty ≦ 1%
		-	2.9	4.0		I _F =1A Pulse Width ≦ 100μs ,Duty ≦ 1%.
Reverse Current	I _R	-	-	10	μA	V _R =5V
Viewing Angle	2θ _{1/2}	-	±28	-	Deg.	

6.TYPICAL ELECTRICAL/OPTICAL CHARACTERISTICS CURVES

(25°C Ambient Temperature Unless Otherwise Noted)

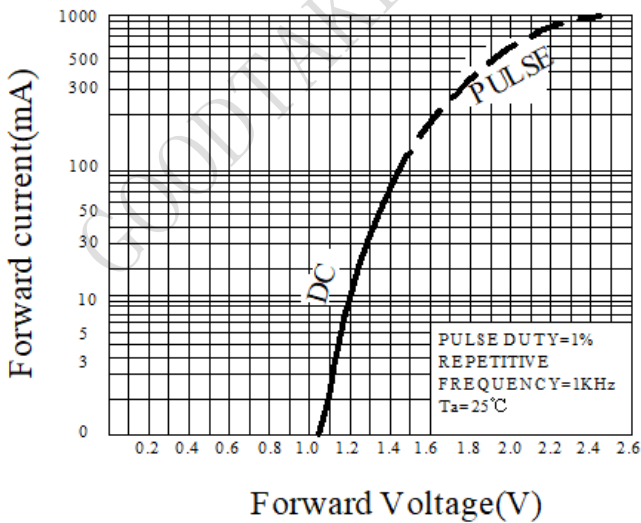

Fig.1 Forward Current Vs Forward Voltage

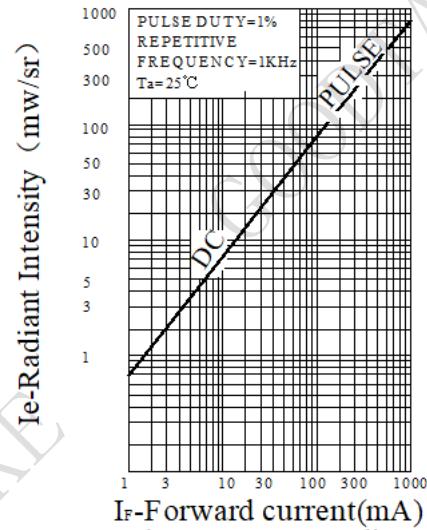

Fig.2 Forward Current Vs Radiant Intensity

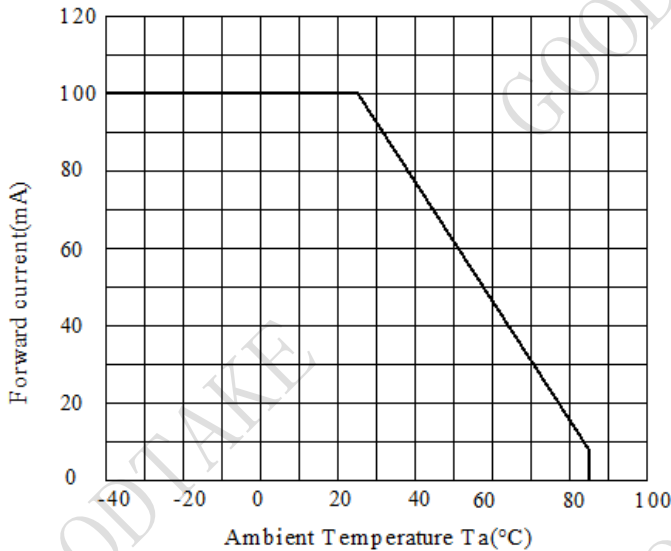

Fig.3 Forward Current Vs Ambient Temperature

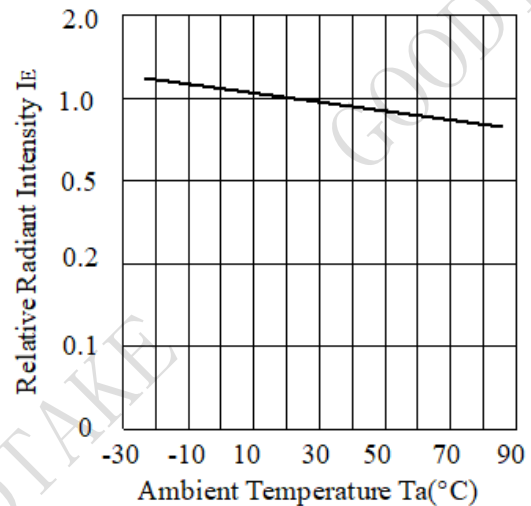

Fig.4 Relative Radiant Intensity Vs Ambient Temperature

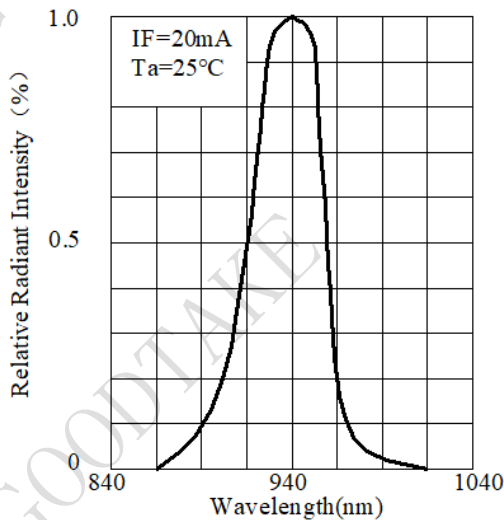

Fig.5 Relative Radiant Intensity Vs Wavelength

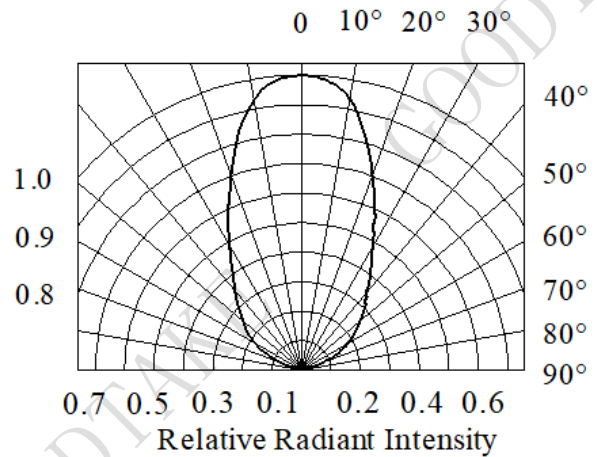

Fig.6 Angle Vs Radiant Intensity

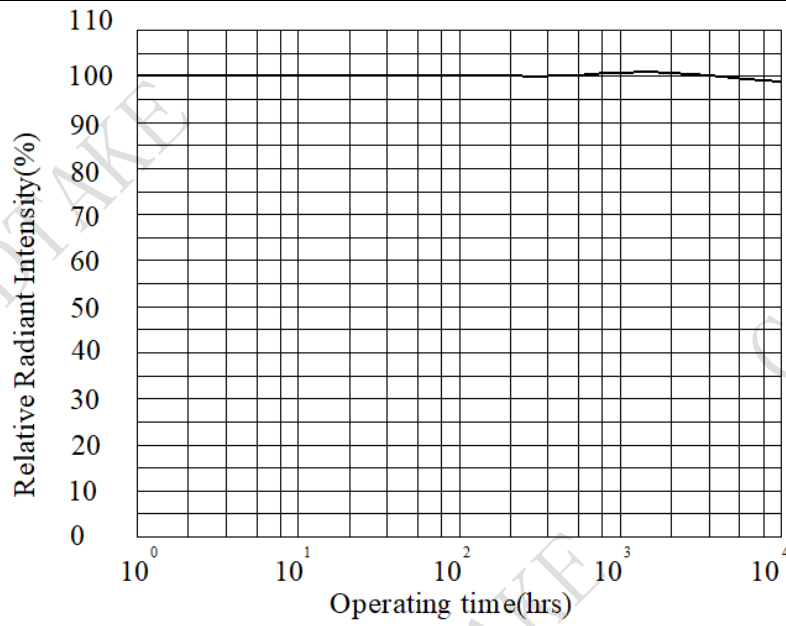
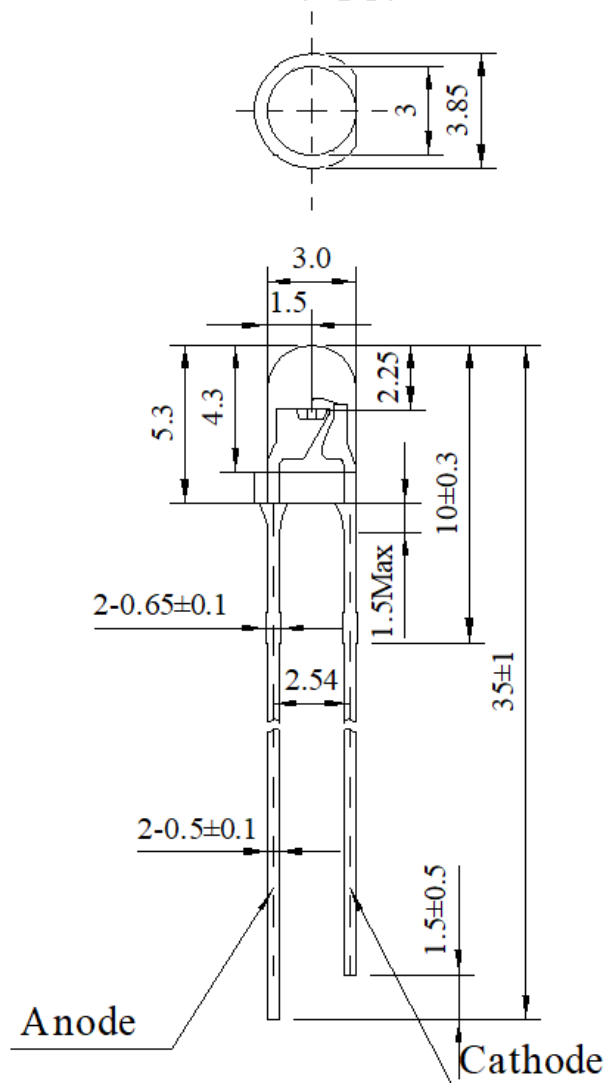

Fig.7 Operating time Vs Relative Radiant Intensity

7.DIMENSIONS



Notes

1. All dimensions are in millimeters.
2. Tolerance is ± 0.2 unless otherwise noted.

8. SOLDERING INSTRUCTION

1. Machine flow soldering – Solder temperature 260 ± 5 °C for 5 seconds, max. 2 times.
2. Manual Soldering –with condition:
 - 2.1 Temperature controlled soldering iron with tip temperature not more than 350 degree °C;
 - 2.2 Finished soldering within 3 seconds;
 - 2.3 Device inserted into PC board of 1.6mm thickness, apply the heated solder tip between the copper pad and wire terminal;
 - 2.4 Do not apply any force to the resin body during soldering and no pre-heat required.
 - 2.5 Solvent cleaning not recommended before cool down of the board assembly.

9.PACKING

Ammo pack radial taped

- 1.Fixed quantity(3000pcs) of the products are packed into inner box
- 2.Ten inner boxes are put into #box(max30.000pcs)
3. Packing slit is pasted on the out box

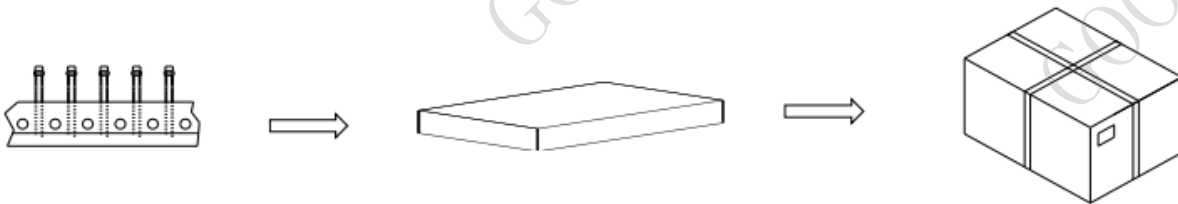

Taping Specification

- NOTE:** 1.All dimensions are in millimeters.
 2.Tolerance is ± 0.3 unless otherwise noted.

